

Avvolgibile in Alluminio coibentato con poliuretano media densità Tipo AS 55

Bloccaggio Stecca



standard
con tappo
laterale spillato



con chiodo
metallico
maggiorazione
del 15%



con tappo
scarpetta spillato
maggiorazione
del 15%
Guide compatibili
A30, A27, guide
in ferro

Profilo in alluminio per avvolgibile a schiuma poliuretana ecologica ad alta stabilità e lunga durata, senza alcuna manutenzione.

Caratteristiche tecniche

Misura nominale	Diametro di arrotolamento	Ingombro (mm) ø 60
12 x 55 mm	<p>Diametri calcolati con molla maxi</p>	altezza -> diametro
Spessore alluminio		1000 -> 140
c.ca 0,33 mm		1200 -> 155
Peso per mq		1300 -> 165
c.ca 3,7 Kg		1400 -> 170
Barre per 1mt di altezza		1500 -> 175
18		1600 -> 175
Larg. massima consigliata		1700 -> 180
4200 mm		1800 -> 185
		1900 -> 185
		2000 -> 195
		2200 -> 200
		2400 -> 210
		2600 -> 215
	2800 -> 220	
	3000 -> 230	
	3300 -> 240	

Profilo AS 55

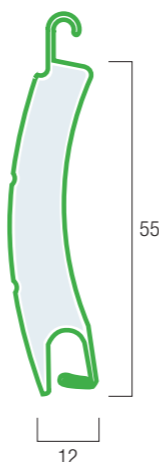

Guide, terminali e accessori compatibili

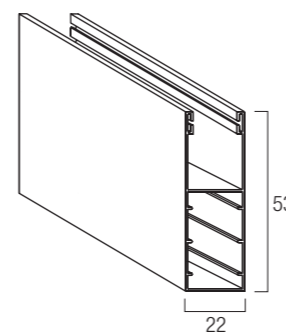

Guida in alluminio A53
GUAL..53M
22 x 53 mm

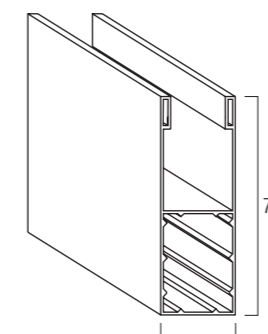

Guida in alluminio A75
GUAL..75M
27 x 75 mm

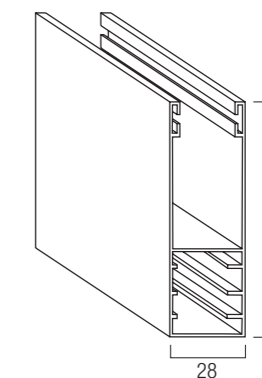

Guida in alluminio A80
GUAL..80M
28 x 80 mm

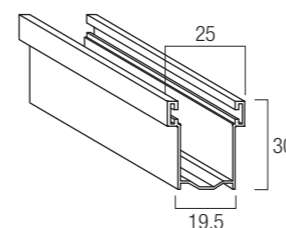

Guida in alluminio A30
GUAL..30M
19,5 x 30 mm

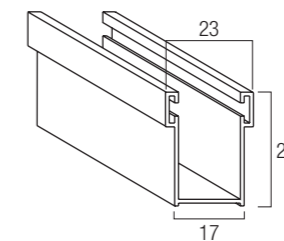

Guida in alluminio A28
GUAL..28M
17 x 28 mm

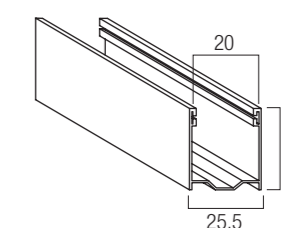

Guida in alluminio A27
GUAL..27M
25,5 x 30 mm

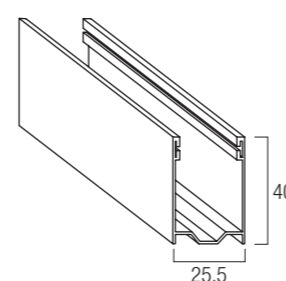

Guida in alluminio A40
GUAL..40M
25,5 x 40 mm

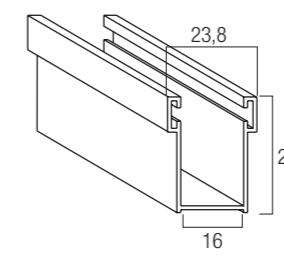

Guida in alluminio A16
GUAL..16M
16 x 28 mm

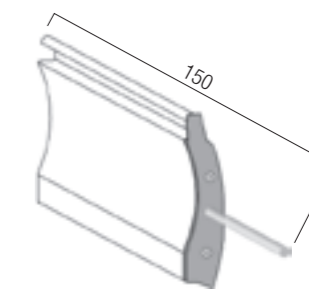

Caten. intermedio di sicurezza per stecca
CATSTE000M
150 mm

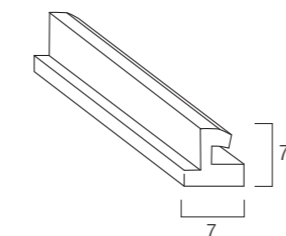

Terminale in pvc
TERPVCRIGMI
7 x 7 mm

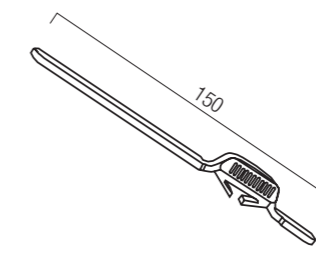

Catenaccio per terminale
CATTER000
150 mm

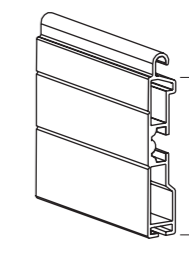

Terminale in alluminio A55
TERAL..14M
55 mm

*minimo di fatturazione per gli avvolgibili solo telo: 1,20 mq

**mazzetta colori a pag. 56