

# Avvolgibile in Acciaio coibentato con poliuretano media densità Tipo CS 55

*Bloccaggio Stecca*



standard  
con tappo  
laterale spillato



con chiodo  
metallico  
maggiorazione  
del 15 %

Profilo in acciaio per avvolgibile a schiuma poliuretana ecologica ad alta stabilità e lunga durata, senza alcuna manutenzione.

## Caratteristiche tecniche

Misura nominale	Diametro di arrotolamento	Ingombro (mm) ø 60
12 x 55 mm	<p>Diametri calcolati con molla maxi</p>	altezza -> diametro
Spessore acciaio		1000 -> 140
c.ca 0,40 mm		1200 -> 155
Peso per mq		1300 -> 165
c.ca 9,0 Kg		1400 -> 170
Barre per 1mt di altezza		1500 -> 175
18		1600 -> 175
Larg. massima consigliata		1700 -> 180
4200 mm		1800 -> 185
		1900 -> 185
		2000 -> 195
		2200 -> 200
		2400 -> 210
		2600 -> 215
		2800 -> 220
		3000 -> 230
	3300 -> 240	

Profilo CS 55

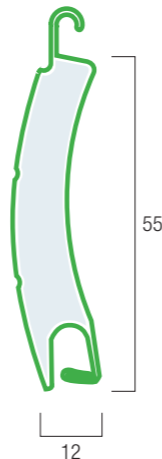

## Guide, terminali e accessori compatibili

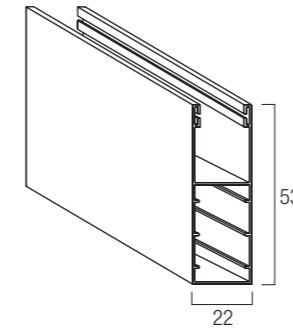

**Guida in alluminio A53**  
GUAL..53M  
22 x 53 mm

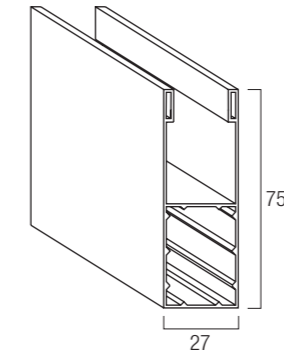

**Guida in alluminio A75**  
GUAL..75M  
27 x 75 mm

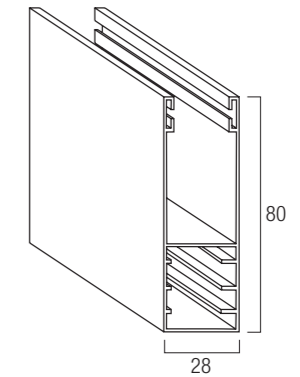

**Guida in alluminio A80**  
GUAL..80M  
28 x 80 mm

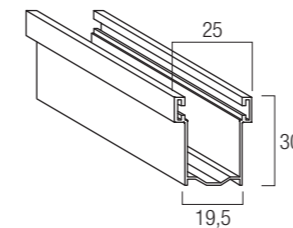

**Guida in alluminio A30**  
GUAL..30M  
19,5 x 30 mm

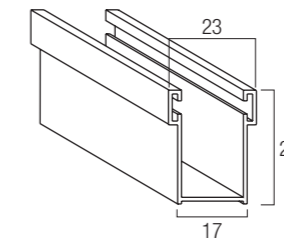

**Guida in alluminio A28**  
GUAL..28M  
17 x 28 mm

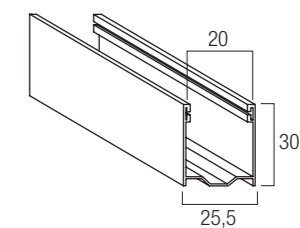

**Guida in alluminio A27**  
GUAL..27M  
25,5 x 30 mm

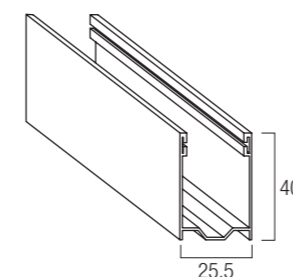

**Guida in alluminio A40**  
GUAL..40M  
25,5 x 40 mm

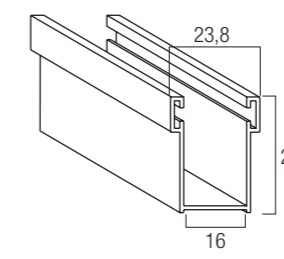

**Guida in alluminio A16**  
GUAL..16M  
16 x 28 mm

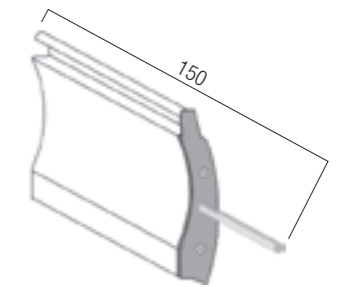

**Caten. intermedio di sicurezza per stecca**  
CATSTE000M  
150 mm

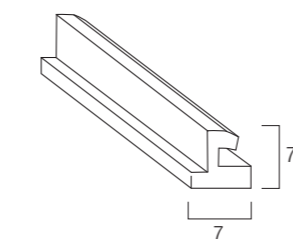

**Terminale in pvc**  
TERPVCRIGMI  
7 x 7 mm

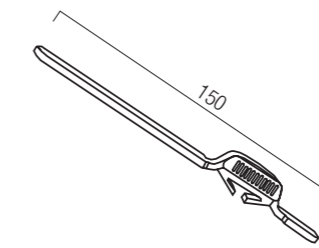

**Catenaccio per terminale**  
CATTER000  
150 mm

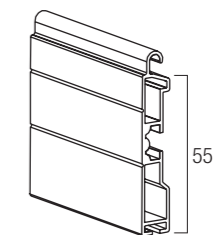

**Terminale in alluminio A55**  
TERAL..14M  
55 mm

\*minimo di fatturazione per gli avvolgibili solo telo: 1,20 mq

\*\*mazzetta colori a pag. 64